

CAPACITOR RETURN

8B0142D-M

SIZE 1/4"

2-WAY Brass, standard port ball valve with electric actuator.

24VDC

Manual Override
5 Sec. Open/Close



ACTUATOR

- NEMA 4, 4X Housing
- 12V/24V AC/DC and 100-240V AC Models Available
- High-Strength, Impact Resistant IP67 PPO Housing
- Comes Standard With 19" Cable

WIRING DIAGRAM

3 Wire control- Power Reset

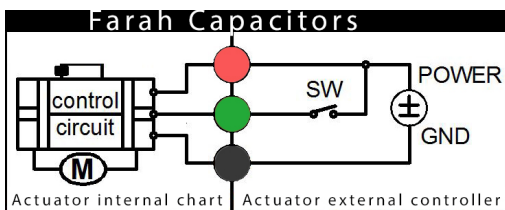

- When the SW circuit is closed the valve will open. The actuator will automatically power off after in place.
- When the SW circuit is open the valve will close. The actuator will automatically power off after in place.

Suitable Working Voltage:

AC/DC 9-24V, DC/AC 110V-230V *

Exceeding the working voltage can potentially cause premature failure.

VALVE FEATURES

- Brass
- Standard Port, Sizes 1/4" to 2"
- Low torque design with capacitor return in case of power failure
- Energy efficient design reduces power consumption needs.

MANUAL OVERRIDE



In case of an electric supply failure, it is possible to operate the actuator manually:

1. Power must be off before using the manual override.
2. Gently pull up the knob turning the knob left or right to open or close the valve.
3. When the red needle in the indicator points to S, the valve is closed. When pointing to O, the valve is open.
4. To resume normal operation the knob must be pushed down.

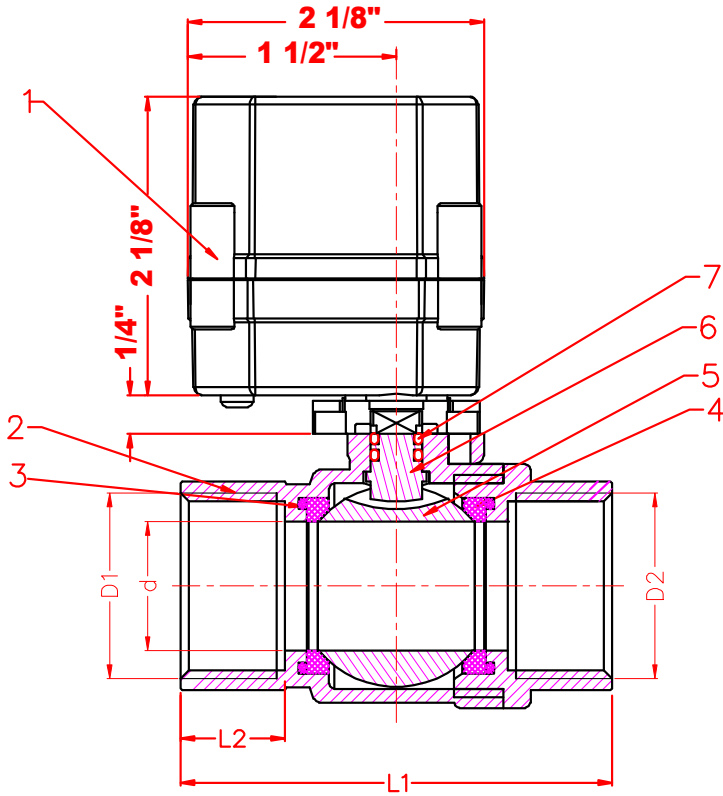

BILL OF MATERIALS

N.POS	PART NAME	MATERIAL	N. PCS
1	Actuator	PPO	1
2	Body Cover	BRASS	1
3	O-RING	EPDM	2
4	Sealing	PTFE	2
5	Ball	Brass	1
6	Stem	Brass	2
7	O-RING	NBR	2

DIMENSIONS

Size	D1/D2	d	L1	L2	E1	H1	H2
1/4"	1/4"	9/16"	1-15/16"	1/2"	13/16 "	3-3/16"	1/2"

